

A SHORT HISTORY OF CLEAR CREEK COUNTY, COLORADO, AND SOME IMPORTANT RESIDENTS

by **John M. Shannon**
Lakewood, Colorado

and **Geraldine C. Shannon**
Lakewood, Colorado

Driving west from Denver on Interstate 70, one travels into the foothills of the Rockies and after approximately ten miles drops into the valley of Clear Creek. It was along this stream that early explorers and travelers discovered the glitter of gold and became part of the 1859 gold rush of Colorado.

IDAHO SPRINGS

After mining in California for a number of years, George A. Jackson, a cousin of Kit Carson (Smiley, 1901), returned to his home in Missouri in 1857. The following year he came to the Pike's Peak region in Colorado. He wintered with Tom Golden at the place where the town of Golden, Colorado, was eventually built.

During January 1859, he and a companion known as Black Hawk tramped the mountains toward the source of Clear Creek (at that time still called Vasquez fork, creek or river), with Jackson eventually going ahead alone, no doubt crossing Squaw Pass (located some five miles south of the present town of Idaho Springs). Apparently he was the first white man to see the hot springs which later made the town of Idaho Springs a famous resort (Gillette, 1978).

Dropping down off Squaw Pass, he camped and explored along what is now known as Soda Creek. On the morning of January 7, 1859 (Henderson, 1926), he moved a little farther west and up the next creek, where he camped as he had done on Soda Creek; the fire he built melted enough snow to expose the

ground and thaw it enough to dig a little with his hunting knife. Using a tin cup to do the washing, he had soon placered enough dirt to show a few flakes of gold and convince him that this might be a worthwhile site. Marking this area for later identification, he returned to his camp in Golden (Gillette, 1978).

Further development of Jackson's discovery had to wait until spring. On April 17, he took a party of men (most of whom were from Chicago, for which the creek was subsequently named) and some supply wagons back to the place he had previously marked. The going was extremely difficult; since there were no roads, the wagons had to be disassembled, carried over barriers and obstructions, and reassembled several times before they arrived at their destination. Having no lumber, the wagon boxes were converted into sluices. The place was called variously Chicago Bar, Jackson Bar, Jackson Diggings, and Sacramento City, and in 1860 became the town of Idaho (the "Springs" was not added to the town name until the Idaho Territory became a reality in 1863 and there was confusion over where to send the mail)(Gillette, 1978).

The first seven days netted the men nineteen hundred dollars in gold, which Jackson took back to Auraria and used in payment for more supplies. (\$1900 equates to approximately 105 ounces of gold at \$18 per ounce.) Because of this, news of the strike spread rapidly and the area soon swarmed with prospectors. The most important of the newer developments on the

upper reaches of Clear Creek at that time were at "Spanish Bar" (probably so-called because it had been discovered by a small party of Mexican miners), which consisted of the creeks and bars in a three-mile area on the western outskirts of Idaho Springs (Gillette, 1978).

It was also during 1860 that Dennis Faivre arrived on the scene. As was probably the case with others, he saw opportunity in this new camp and by driving a team of oxen laden with miners' supplies into this area, he became its first merchant.

From a base at Idaho and the well-established mining area of Central City to the north, prospectors began arriving and proceeded to explore many of the other creeks and valleys in the area, eventually establishing the many other mining communities in Clear Creek County.

GEORGETOWN

Farmers George and David Griffith, coming from Bourbon County, Kentucky, reached the Denver area on October 25, 1858. Early in May of 1859, they heard the news of John H. Gregory's discovery, which caused a wild rush to the area of Black Hawk and Central City. Unfortunately, the Griffiths arrived too late to get any of the better claims. George, leaving his brother in Russell Gulch (located

approximately four miles to the north of the present town of Idaho Springs), finally arrived at the camp that was then called Sacramento or "Idahoe." He continued to prospect upstream on Clear Creek until he finally arrived in a much less populated area. Finding some likely looking ground, he scraped up some gravel for his pan and was elated to find a glitter of gold. He staked the claim and immediately returned to Russell Gulch to get his brother. That summer the two brothers and three other men took out \$500 in gold and by common consent called their camp "George's Town." During the spring of 1860 they returned with their brothers William and John, John's wife Elizabeth and their father, and together they staked the entire valley as a homestead and built a cabin (Wolle, 1949 and Gillette, 1978).

"By 1866 there were really two camps a half a mile apart, separated by a beaver dam. The original camp, Georgetown, was located on the flat beside the creek, but as more men arrived, buildings were constructed at the base of Leavenworth Mountain, and this 'suburb'. . . was called Elizabethtown after John's wife. When the place was granted a post office in 1866, a public meeting was held and both camps agreed to combine under the name of Georgetown" (Wolle, 1949).

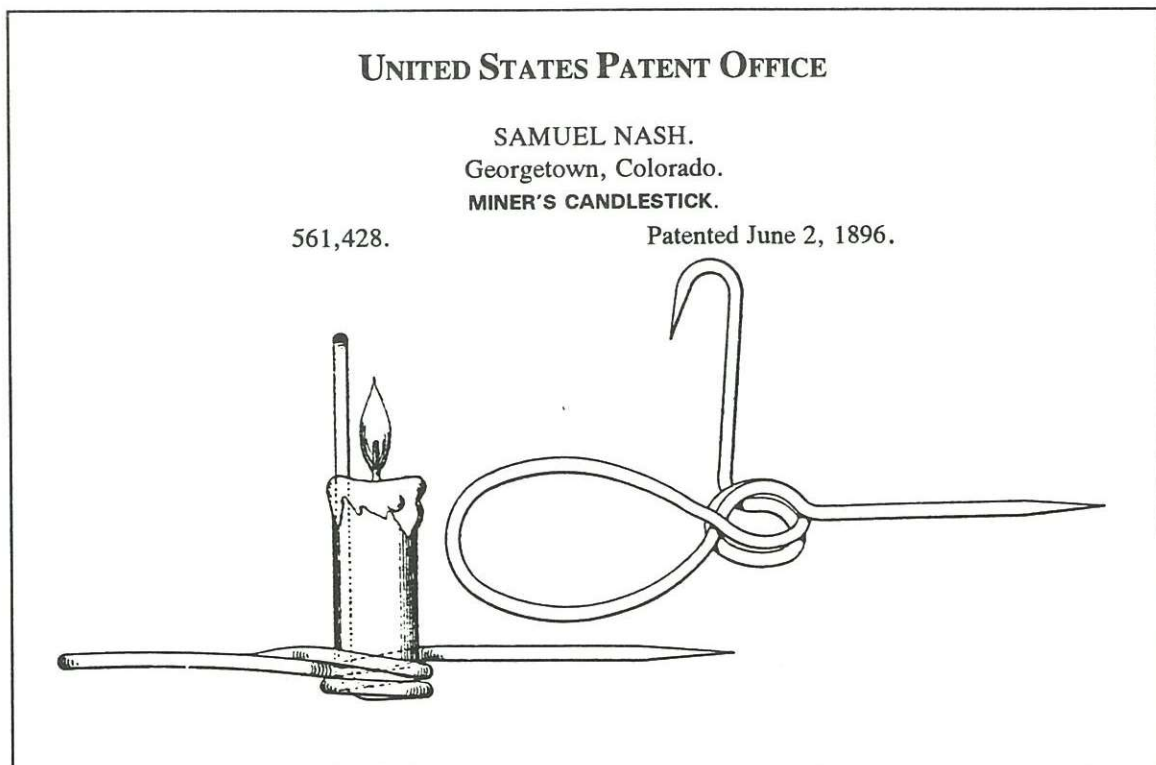

EMPIRE

Toward the end of August in 1860, Edger Freeman and H.C. Cowles came over the mountains from Central City in Gilpin County and dropped down into a valley located approximately ten miles west of Idaho Springs. They prospected and found two bits of wire gold on Eureka Mountain. Those two small pieces of gold sparked discovery of the Empire and Keystone lodes and the organization of mining districts in this area. People came from Gilpin County and upstream from Idaho Springs, building cabins and bringing prosperity for several years (Frost, 1880).

D.C. Daley, one of these miners, has the distinction of discovering the first silver lode in Colorado, the Ida Lode on Silver Mountain near Empire, in September 1860. It was assayed and found to contain 100 ounces of silver per ton. This was not an isolated case. Documentation exists regarding two claims in the Union District (Empire) and one in the Lincoln District (Alice). However, in the rush to find gold, the silver "leads" didn't get the attention they should have until 1864 (Frost, 1880).

From 1860 to 1865 Empire was very prosperous, owing to the ease with which gold could be sluiced from decomposed quartz lodes, which could be treated in the same way as placer gravel (Henderson, 1926).

In September 1864, R.W. Steele, James Huff and Robert Layton started out in search of silver, which they expected to find in and around the range near the headwaters of the southwestern branches of Clear Creek. They discovered the Belmont silver lode in the East Argentine District that month. The primary importance of this event is that it "first awakened the public to a sense of importance and value of Clear Creek's argentiferous veins" (Frost, 1880).

SILVER PLUME

Although prospecting and gulch mining were certain to have taken place in the valley about two miles west of Georgetown, it was not until 1870 that it became a full-fledged mining camp. Several mining companies existed there and about twenty men worked the Snowdrift, Silver Plume and other lodes. The Silver Plume

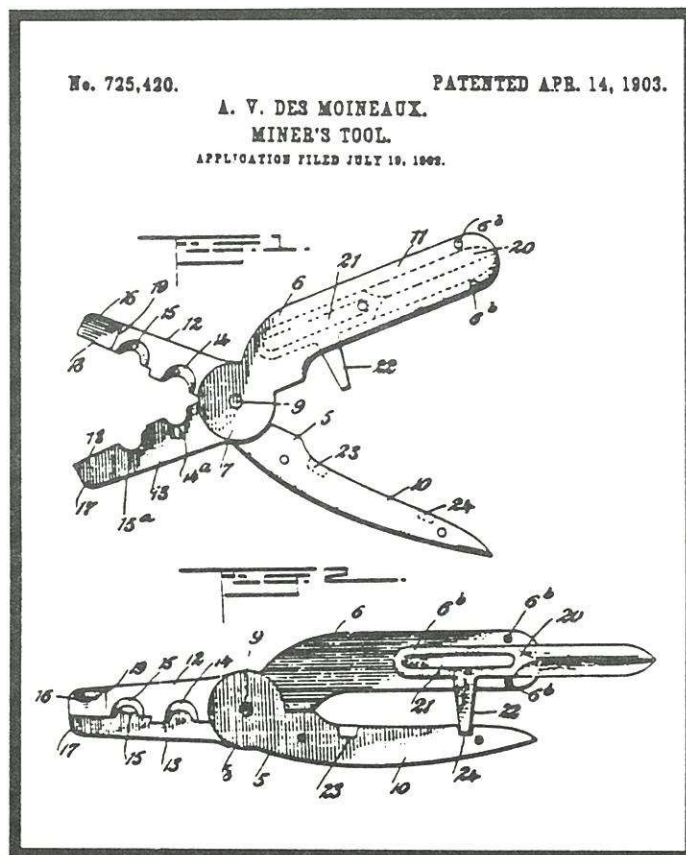

Mine, having been named for the white streaks of silver which appeared "plume-like" in the rocks, is probably the source of the town name.

Much of the early notoriety of Silver Plume stems from the story of Owen Feenan and the Pelican Mine, which he discovered during his off-hours while employed in another mine. Becoming dangerously ill and believing that he was going to die, he confided to two friends the location of his mine. For more than a year he hovered between life and death and when he finally recovered, it was only to learn that the mine had been opened in the spring of 1871 and that he had been completely left out of the transaction. Shortly after, it was found that the Pelican and the Dives had been working the very same silver vein, and of course each management thought the other had been stealing. This circumstance brought on many squabbles between the two mines. At one time there were more than twenty lawsuits and counted-suits pending between the two mining companies. Both mines were eventually purchased by W.A. Hammil, of Georgetown, and the Pelican-Dives came into being (Brown, 1968).

Samuel Nash was born January 10, 1842, in London, England, and immigrated to the United States in 1843 with his parents. They spent a short time in Morris, Illinois, before moving on to Chicago in 1860. It was here that Sam enlisted in the Illinois Volunteers and served until 1864. He arrived in Georgetown in 1867, where he was a tinsmith living at 206 Rose Street at least as early as 1871. He and his wife Alice had three children, two of whom survived to early adulthood: Edward S. born in 1881 and Clyde H. born in 1883. Nash was known to have made excellent tinware and copperware, but for the mining collector he was most famous for his wire candlestick. We can conjecture that after repairing numerous sticks and seeing the need for a rather inexpensively made model, he designed the wire stick that was finally patented on June 2, 1896, patent No. 561,428. (See Wilson/Bobrink, 1984, p. 52, No. 86.) At one point his candlesticks were wholesaling for 10 cents apiece. In 1892 Samuel Nash's advertisement indicated he was a plumber, a tin, sheet iron and copper worker, and a dealer in stoves, tinware, hardware and cutlery. Some of his tinware patterns, as well as tinsmithing equipment, can still be found in Georgetown. A lunch box and a powder tin in the collection of Leo Stambaugh in Georgetown are gangstamped "S. Nash." Sons Clyde Nash died in 1917 and Edward in 1919; By this time Sam was 77 years

old. Since he was not listed in the Colorado Business Directory after 1919, we assume he closed his business and retired. Samuel Nash died September 18, 1927, and is buried in Georgetown (U.S. Census 1880, 1900 and 1910, Obituary 1927).



Shown above are two examples of the tinware of Samuel Nash. On the left is a lunch bucket stamped "Nash" and on the right is a powder carrier stamped "S. Nash."

Shown below is an original photograph of the town of Silver Plume dated 1889. (Ted Bobrink collection)

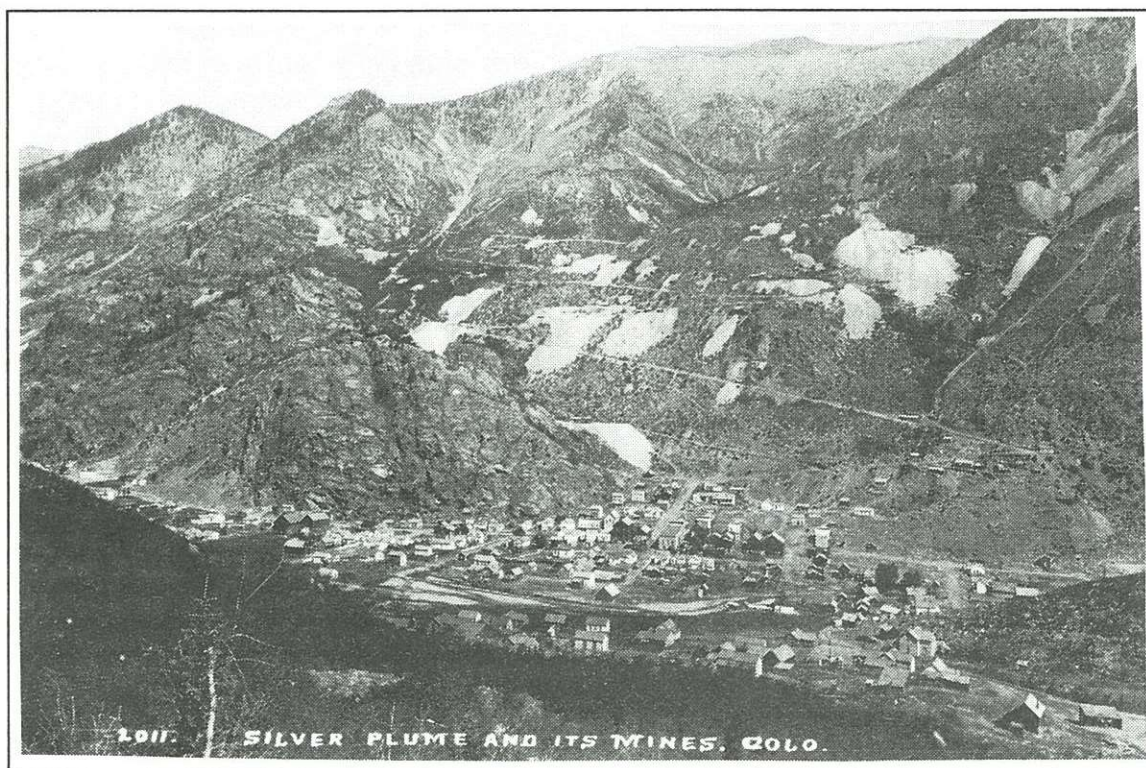

LAWSON AND DUMONT

Mill City was first inhabited by some Californians who pitched their tents in the area in 1859. As mines were discovered, cabins were built, along with several stamp mills and smelting furnaces; the community became a smelter and milling center. Unfortunately the mines didn't live up to expectations and although mining continued, the small city didn't prosper. John M. Dumont eventually became the owner of several of the big mines--the Whale, the Freeland, the Lincoln and others. Around 1880, he made every effort to revive Mill City, but only succeeded in causing Mill City to be renamed Dumont (Eberhart, 1959).

In 1872, Alexander Lawson built a new inn six miles downstream from Georgetown and called it the Six Mile House. Lawson ran the inn, owned a freighting business serving Central City, Black Hawk, Leadville and Georgetown, and operated a stage-coach line between Georgetown and Silver Plume. New mines were discovered in 1876, causing an influx to the area; the resulting town was named Lawson. The workings on Red Elephant Hill and at Silver Creek in the eighties increased the population to 500, including development of a reduction works, four stores, a school and a post office (Wolle, 1949).

Other mining towns such as Silver City (Alice), Freeland, Lamartine, Red Elephant, Swansea, Growville, Mexico, Ocean Wave, Soda City, Mad Creek, and Chinn's Town have long since disappeared. Only a few homes and service stations still mark the existence of Lawson, Dumont, and Downieville.

EARLY ENTREPRENEURS

On the heels of the miners came merchants, doctors, lawyers, newspapermen and others, all anxious to make a living providing the needs of these "soon to be prosperous" miners and mine owners. Because of the remoteness of these new mining communities, those who were imaginative and innovative were quick to realize particular needs, whether large or small. Although much of the larger mining machinery would come from businesses in Denver and the fast-growing Central City, many mining inventions would come from local blacksmiths, tinsmiths and miners who were able to bring their ideas to fruition.

One of the earliest to patent a new mining idea in Clear Creek County was Neils Larsen. He was born in April of 1841 in Copenhagen, Denmark, where he learned the blacksmith's trade. In 1864 he arrived in the United States and spent a year in Michigan working at the machine-shops in Grand Rapids. He then came to Golden, Colorado, and from there went to Central City for a short time. He tried his hand at prospecting at Mill City (Dumont), where he developed his idea for a folding candlestick. The Larsen candlestick may be the earliest manufactured folding candlestick. (Further discussion on this possibility may be found in an article by Ted Bobrink in *MAC* #19 Summer 1993, p. 3.) His patent was No. 151,297 and was dated May 26, 1874 (Wilson, 1983 and Wilson/Bobrink, 1984). In May of 1878 he moved on to Leadville; there he became famous as the discoverer of the Highland Chief Mine and eventually became the operator of the Big Chief Mine (Frost, 1880).

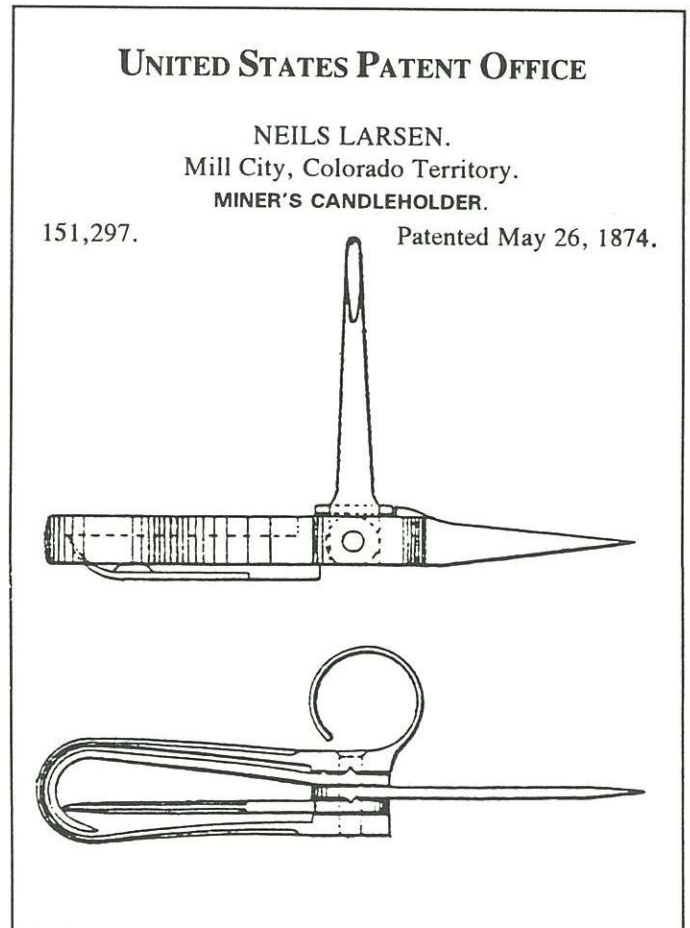

The original patent drawings for a Miner's Candlestick patented by Neils Larsen of Mill City, Colorado Territory, on May 26, 1874.

UNITED STATES PATENT OFFICE

CHARLES P. DESMOINEAUX
Leadville, Colorado.

COMBINED MINER'S CANDLESTICK AND LOADING TOOL.
264,636. Patented Sept. 19, 1882.

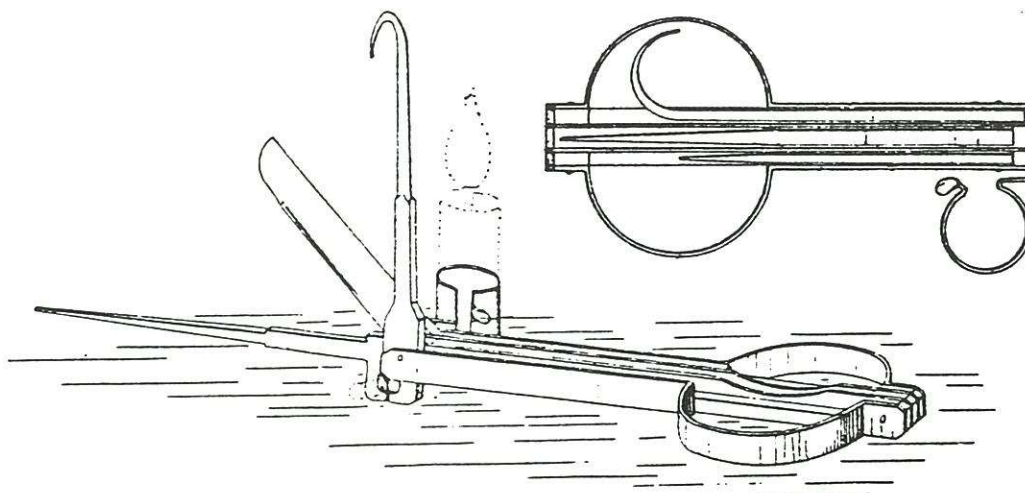

Silver Plume was the home of another inventor, Alfred Victor DesMoineaux. Donza, France, in 1828 was the birthplace of Alfred's father, Charles, who at an early age served in the French Navy. Upon being discharged, he sailed to Havana, Cuba, bought a supply of coffee, sugar, rum and tobacco and sold it in St. Louis, Missouri, at a profit. In Iowa, he met and married Sara Moorehausen and not long afterward they moved to Colorado. Charles ran a bakery in Central City and became involved in a number of mining ventures. It was here they raised their family, a daughter and five sons, including Alfred Victor, who was born in October of 1862. After living for a time in Black Hawk, the family moved to the Silver Plume area and by 1880 they lived in Brownville, where father Charles became the postmaster. (Located a short distance beyond Silver Plume, Brownville was buried under a massive mudslide in its early years and the original townsite is now under Interstate 70.) It was also during this time that son Charles P. ventured out to Leadville; while living there, he invented and patented a folding candlestick (see Wilson/Bohrink, 1984, p. 116). In 1883 Alfred

Shown above is the original patent drawings for a Combined Miner's Candlestick And Loading Tool patented on September 19, 1882, by Charles P. DesMoineaux of Leadville, Colorado.

Shown to the right is a close-up view of C.H. Garland's fancy "Lady's-leg" candlestick. The hook is threaded and inserts through a hole in the shaft and screws into place.

Victor, together with brother Frederick Leon, moved to Creede, where they became involved in the Solomon Mine. They were successful in their business ventures, at one time owning a hotel, a restaurant and several houses. It was also in Creede that Alfred Victor met and married his wife Helen. In 1899, word came from Silver Plume of a death in the family and they immediately packed up and moved back to Silver Plume. It was there in 1902 that Alfred Victor invented and patented his Miner's Safety Loading Tool (see *MAC* #7, p. 25). Alfred also became a friend of John Lindahl and often helped assemble Lindahl's famous matchesafe candlesticks (DesMoineaux, 1993).

Charles Henry Garland was born in Lands End, Cornwall, England, in March of 1842 and along with his wife Mary and three children immigrated to the United States in 1867. Around 1870 he moved to Central City and later to Silver Plume, where he gained a reputation as a top-notch blacksmith. The Garlands had ten children living with them in Silver Plum and additionally took in four boarders. One source indicates that Garland Street in Silver Plume was named for him. He made the folding combination-lock candlestick pictured here. These desirable collector candlesticks, which were never patented, were originally made around April 1, 1889, (the date stamped on the candlestick) and raffled off to local miners to help pay for fire equipment for the town of Silver Plume. Garland also plied his blacksmithing trade in Aspen before moving to the state of Idaho, where he died in 1926. One of his candlesticks and a set of his miniature mining tools are in the collections of the Idaho State Historical Museum in Boise. In addition to the combination-lock candlestick mentioned above, he also made a fancy lady's-leg candlestick with a removable hook (Garland, 1993).

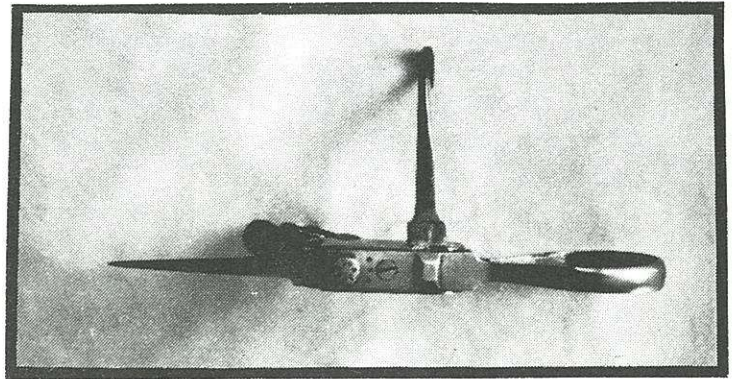

The top photo is of the C.H. Garland combination lock folding candlestick in the open position. The lower photo is of the C.H. Garland combination lock folding candlestick in the closed position. The folding candlestick shown here is one of four C.H. Garland combination lock folding candlesticks known at this time.

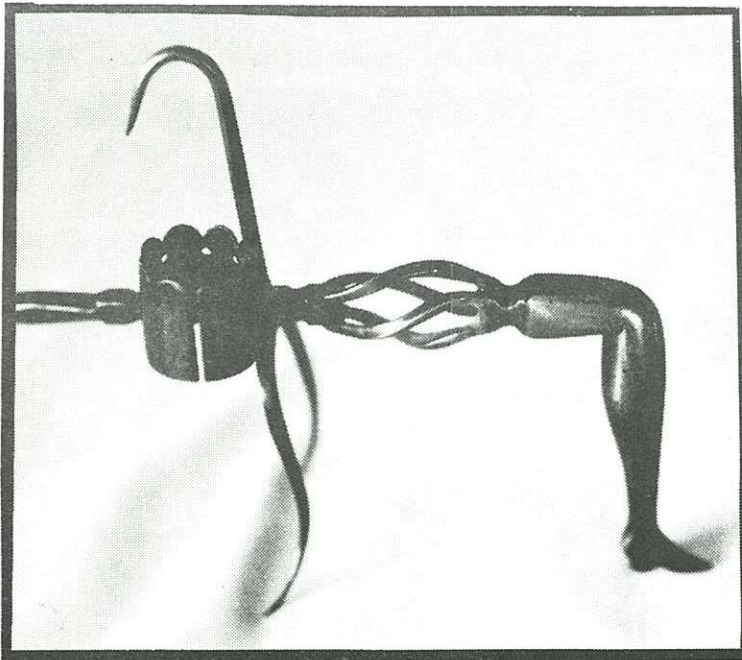
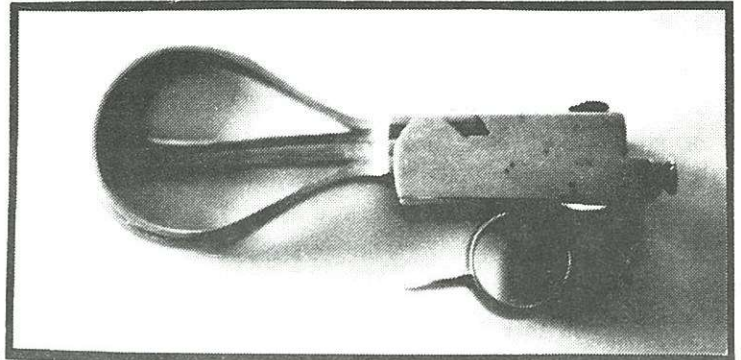

The honor of being the first Colorado-born manufacturer of mining machinery goes to John George Leyner, who according to some sources was the first white child to be born in Boulder County. The date was August 26, 1860. "Leyner as a youth had worked in Colorado mines, specifically at Silver Plume, where he studied the faults of hand operated drills under the old 'single' and 'double-jack' methods, also the failures of the first steam-operated drills to alleviate the dust danger to the miner. Leyner invented a compressed-air-driven hammer drill which rotated in the hole, thus speeding up the drilling process. Another improvement he added was the introduction of holes in the head of the

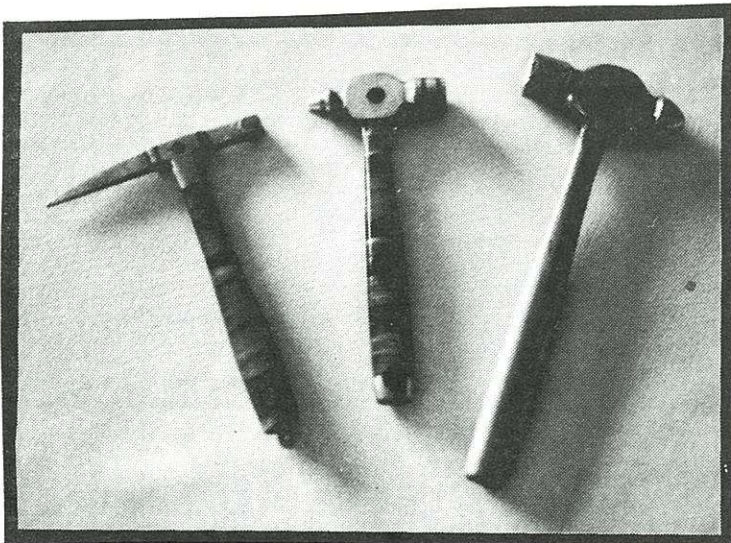

Shown above are the miniature tools of C.H. Garland. The hammer length is approximately 1 1/2 inches long.

drill so that a stream of water could be injected, and the dust allayed" (Mitick, 1947). He eventually built offices and shops in the Denver area and in 1904 his drills, compressors and hoisting equipment took prizes in the St. Louis World Exposition of 1904. An auto accident in 1921 resulted in his death and caused the interests of the company to be sold to Ingersoll-Rand (Mitick, 1947).

Anthony J. August was a miner living in Georgetown in 1871, having come from New York with his wife Mary and son Joseph around 1868. However, the 1880 United States Census indicates he was living in Lawson and dealing in grain and hay, so he must have decided that mining was not in his best interest. In 1888 he teamed up with Albert Vannatter and developed a cap crimper with fuse cutter which was patented on January 17, 1888, (patent No. 376,493). According to the Census, neither he nor Vannatter was in Clear Creek County in 1900.

These are but a few of the men across the United States who developed their ideas in an effort to make a little extra money to support their families and at the same time make the miner's job a little easier. We as collectors know of the tools they made, but perhaps these stories will help us appreciate the people themselves and the contributions they made to the mining industry in the United States.

ACKNOWLEDGMENTS

Special thanks to Leo Stambaugh, who not only furnished items from his personal collection for photographs, but also assisted with research and supplied much information regarding some of the families.

BIBLIOGRAPHY

Bancroft, H.H. (1890) *The Works of Hubert Howe Bancroft Vol. XXV*. The History Company, San Francisco.

Bobrink, Ted (1990) The Nash Candlestick from Georgetown, Colorado. *Mining Artifact Collector*, Issue No. 6 Winter 1990.

Bobrink, Ted (1990) The John B. Lindahl Patented Match Safe Candlestick. *Mining Artifact Collector*, Issue No. 7 Spring 1990.

Bohannon, Mark (1990) Patented Cap Crimpers. *Mining Artifact Collector*, Issue No. 7 Spring 1990.

Colorado Gazetteer for 1871 (1870) S.S. Wallihan & Co., Denver.

DesMoineaux (1993) Personal communication with family.

Eberhart, Perry (1959) *Guide to Colorado Ghost Towns and Mining Camps*. Sage Books, Denver.

Frost, A. (1880) History of Clear Creek County. *History of Clear Creek and Boulder Valleys, Colorado*. O.L. Baskin and Co., Chicago.

Garland (1993) Personal communication with family.

Gillette, E.M. (1978) *Idaho Springs: Saratoga of the Rockies*. Vantage Press, New York.

Henderson, C.W. (1926) Mining in Colorado. USGS Professional Paper 138. Government Printing Office, Washington D.C.

Mitick, E.C. (1947) *A History of Mining Machinery Manufacture in Colorado*. Unpublished manuscript, University of Denver.

Smiley, J.C. (1901) *History of Denver*. Times Sun Publishing Co., Denver.

Wilson, W.E. (1983) *Miners' Candlestick Patents*. Mineralogical Record Inc., Tucson.

Wilson, W.E. and Bobrink, Ted (1984) *Miners' Candlesticks*. Mineralogical Record Inc., Tucson.

Wolle, M.S. (1949) *Stampede to Timberline*. Swallow Press, Chicago.